



AAKCCB74 系列說明書 AAKCCB74 INSTRUCTION MANUAL

KWT KWIEN WELL TOY INDUSTRIAL CO., LTD
www.kwcgun.com

台南市仁德區義林路168巷89號
NO.89, LN. 168, YILIN RD.,
RENDE DIST., TAINAN CITY
71752, TAIWAN (R.O.C.)
TEL : +886-6-2798175
FAX : +886-6-2798176
sales@kwcgun.com
www.kwcgun.com



操作/OPERATION

操作說明 OPERATION

1. 取出彈匣 RELEASE MAGAZINE



▲注意: 請勿使彈匣直接掉落地面, 以防止變形或損壞。

▲CAUTION: Magazine falling directly on the ground could cause deform or damage on it. Please be aware.

2. CO2小鋼瓶12g的使用 INSTALLING 12G CO2 CARTRIDGE

逆時針轉出彈匣底內件後, 置入小鋼瓶B, 再以順時針方向鎖緊彈匣底內件A。當刺破鋼瓶出氣時, 請快速鎖緊。

Turn the magazine cap out counter-clockwise and place CO2 cartridge B inside the magazine. Rapidly turn the screw A clockwise when piercing the cartridge in the magazine.

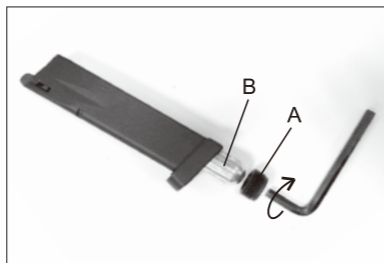

▲注意: 為維護彈匣使用壽命, 請盡可能不要殘留CO2氣體於彈匣內。

▲CAUTION: To protect your magazine, please release all of the CO2 out of the magazine after every use.

3. 填裝B.B彈
LOADING BB BULLET
為了使擊發順暢, 填裝方法是讓B.B彈在彈匣中一粒接著一粒。
For smoothly shooting, load the BBs one pellet by one pellet.

▲注意: 彈匣最多可裝 24 發 B.B 彈, 如強行裝入更多, 可能造成不當損壞及無法上膛, 請注意。

▲CAUTION: BB's max capacity is 24 rounds. If you load more than this quantity, you would bring any abnormal problems.

4. 彈匣上膛
INSERTING THE MAGAZINE
將裝好B.B彈的彈匣插入槍身上推入, 直到彈匣卡榫發出“卡嗒”為止。
Insert fully loaded magazine in the airsoft until you hear the sound of “CLICK”.

5. B.B彈上膛
CHAMBERING THE BB
將上蓋往後拉到到底, 放開上蓋則上蓋會自動回位, 同時亦將B.B彈送上膛完成射擊準備。
Pulling the slide back. When the slide has been pulled completely back, release the slide without pushing and the BBs will be chambered.



▲注意: 拉動上蓋時, 請勿將手指扣住扳機, 以免發生不當射擊, 造成危險。

▲CAUTION: The gun is now cocked and will fire when the trigger is pulled. Be careful not to fire accidentally.

6. 保險切換 SWITCH SAFETY

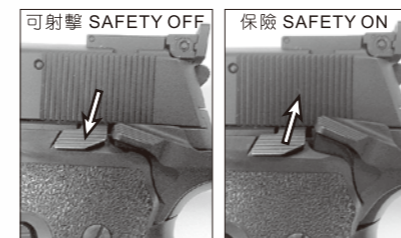

建議: 有時開關保險時會有阻力, 建議用2指來扳動保險開關較易
Suggestion: Safety switch is a little bit hard. We suggest to switch both sides at once.

▲注意: 必須在上膛狀態下保險才可關閉
▲CAUTION: Safety can only be turned on when this airsoft is cocked.



▲注意: 上蓋滑動時, 注意縫隙夾到手指。
▲CAUTION: This airsoft has a realistic blowback feature. Be careful of the pinch point.

7. 後準星調整 Rear sight adjustment

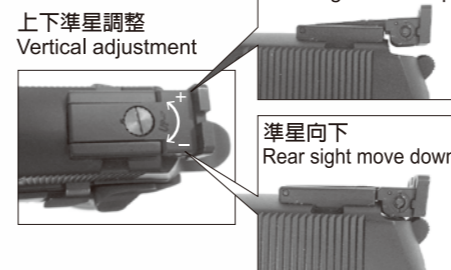

上下準星調整
Vertical adjustment

左右準星調整 Horizontal adjustment

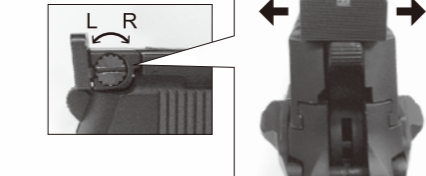

8. 射擊
SHOOTING
對準目標區後扣下扳機, 則B.B彈將被射擊出去。
Aim the target and pull the trigger. Then the BB will be shot.



▲注意: B.B彈用完時, 上蓋會後定卡住。
▲CAUTION: hold open function as real pistol.

拆解/DIS-ASSEMBLY

1. 按下卡榫, 取出彈匣
Press the magazine catcher to release the magazine



3. 旋轉導管卡榫至下方
Spin the Assemble Key down as picture



故障/BREAK DOWN

4. 上蓋即可取出 Remove the slide.



5. HOP UP調整 Adjust HOP UP system.



故障的原因與排除 BREAK DOWN FAQ

* 卡彈可能原因:
the reason for BB jam:
a. 裝彈排列不整齊
the BB in the magazine does not arrange very well.
b. 不良B.B彈
bad quality BB
c. 空擊發易造成零件損耗, 請避免此動作。
Please avoid dry firing, for it could cause parts deformed or damage.



* 排除: 將上蓋往後拉, 向下倒出即可。
elimination: pull the slide back and pour the BB out from slide.



* 射擊過程中偶而會發生, 在作動時上蓋突然停止無法作動, 而擊鐵回到原位, 彈匣中仍有足夠瓦斯和B.B彈。
In the shooting, sometimes you will meet with Slide and Hammer Stopping unexpectedly.



* 排除: 此時並非故障, 只需重新上膛便可繼續使用。
SOLUTION: This is not the failure. Just reload it and operate again.

* 保養及維護 MAINTENANCE GUIDE

當射擊約2000發時, 建議你如圖所示, 以矽油脂適當在上蓋與本體滑動接觸面及擊鐵、撞針作動處潤滑, 以利滑動。
We recommend you to use the lube oil to spray into the position as picture such as firing pin and track when you shoot the gun over 2,000 BB Shots.



WARNING 警告

請務必嚴格遵守 使用說明指導書 READ THIS OWNER'S MANUAL COMPLETELY.

此低動能遊戲用槍是針對喜愛射擊運動的消費者所開發。避免因使用方法不正確或改造所發生的故障或事故，請務必詳讀說明書，正確的操作享受愉快的射擊運動。

- 除了發射時外，不要將手指頭掛在板機上。
- 選擇安全與適當標靶
- 在非使用期間，請保持保險關閉且退彈的狀態，就算在非使用狀態，也要如同其已裝彈。
- 如任何的機械產品，槍的保險也可能失效。即使在保險關閉的狀態下也請小心的操作此槍，請勿將槍口對人。
- 千萬不要對堅硬或平坦表面、水面射擊，以避免跳彈。
- 請妥善保管產品在未未成年孩童無法伸手取得的場所。
- 每次使用前後都應該檢查擋彈物，假如擋彈物表面有磨損失效或是反彈時請停止使用。
- 請使用高品質BB彈，請勿使用①口徑大於6mm②表面不平滑的③重複使用過的BB彈④非本說明書指名的發射物。
- 最高的使用及儲藏CO2小鋼瓶環境為50°C(122°F)以內，高溫可能會造成CO2小鋼瓶過熱甚至爆炸。
- 檢查任何掉落之槍枝，以確保未影響其功能。

This airsoft is intended for recreational or training purposes. To prevent improper handling, modification or alteration causing malfunction or accident, please read the owner's manual carefully. Enjoy the pleasant shooting experience by proper operation.

- Do not put your finger on the trigger except shooting.
- Please choose safe and proper target.
- Please always keep the airsoft on safe and unloaded when not using.
- Like all mechanical devices, an airsoft safety can fail. Always handle the airsoft safely even when the safety is "on safe". Never point the airsoft at any people.
- Avoid ricochet. Never shoot at a hard or flat surface or at water.
- Keep the airsoft out of reach for small children.
- Your backstop should be inspected for wear before and after each use. Discontinue use of the backstop if surface shows signs of failure or ricochet.
- Only use high quality BB. Never use ①BB diameter larger than 6mm②BB with unsmoothed surface③reused BB that has been fired④incorrect projectiles not design for this airsoft
- Do not expose CO2 cartridges to heat or store them at temperatures above 50°C(122°F). CO2 cartridges may over heat or explode at temperatures above 50°C(122°F).
- Check any gun that has been dropped to ensure that its function has not been affected.

★使用玩具槍前，請務必戴上保護眼鏡或面罩。
★Always wear eye protection when using airsoft.

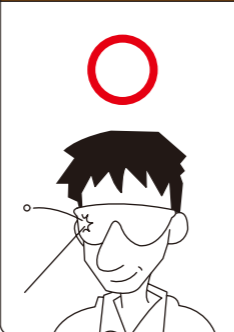

★不可攜帶玩具槍在公共場所行走，請務必裝在袋子或盒子內。
★Always transport an airsoft in a locked carrying case. Make sure it is unloaded and on safe.



★使用玩具槍前，請務必詳讀說明書內容。
★Read the owner's manual before using the airsoft.



★請不要由槍口向內探視。
★To Avoid accidental discharge, do not look directly into the barrel.



★請不要在公開場合使用玩具槍，也請不要拿玩具槍對準人或動物。
★Never brandish or aiming this airsoft at any people or domestic animals. Brandish this airsoft in public is dangerous and may be a crime.

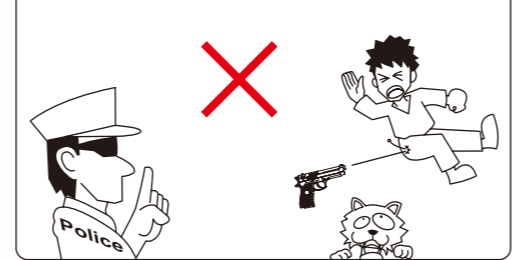

★請確認後再發射BB彈方向，附近無人或動物存在。
★Always be aware of your surrounding before and during shooting and select a safe area for target practice.

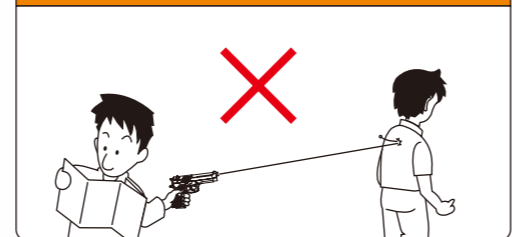

★不可任意改造或加工玩具槍，私自改造加工會造成產品損壞、保固失效，導致使用上不安全，甚至觸法送辦。
★Disassemble, modify, or alter of your airsoft may cause malfunction, void your warranty and may make it unsafe to use.

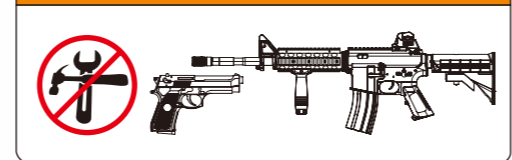

Do not display this pistol in public—it may confuse people and may be a crime. 請不要忘了，雖然自己知道這只是玩具，但不知道的人，會以為這是真槍。

AAKCCB74 系列零件表 AAKCCB74 SERIES PARTS LIST

NO.	零件名稱	UNIT	NO.	零件名稱	UNIT	NO.	零件名稱	UNIT
P03	滑套射嘴	LOADING NOZZLE	Z32	後準星罩門	SEAR SIGHT PLATE	S01	彈匣卡榫扭簧	MAGAZINE CATCH SPRING
P04	槍柄(左)	GRIP (L)	Z34	槍柄座	GRIP BASE	S02	導管卡榫軸壓簧	SLIDE CATCH PIN SPRING
P05	槍柄(右)	GRIP (R)	Z35	彈匣本體	MAGAZINE FRAME	S03	扳機扭簧	TRIGGER SPRING
P06	彈匣上部(大孔)	MAGAZINE RIB	Z36	前準星	FRONT SIGHT	S04	上蓋止動片壓簧	SLIDE STOP CATCH SPRING
P07	彈匣滑粒	MAGAZINE FOLLOWER				S05	扳機連桿扭簧	TRIGGER BAR SPRING
KG15-P08	氣缸迫緊	BREECH PACKING	F01	上蓋止動片	SLIDE STOP CATCH	S06	擊鐵壓簧	HAMMER SPRING
P10	BAX可調旋鈕	BAX ADJUSTOR	F02	扳機連桿	TRIGGER BAR	S07	撞針卡榫壓簧	FIRING PIN CATCH SPRING
KMB15-P10	心棒迫緊	VALVE PACKING	F03	擊鐵壓簧導桿	HAMMER SPRING GUIDE	S08	撞針拉簧	FIRING PIN SPRING
P14	槍管導桿護套	RECOIL SRPING GUIDE CAP	F04	子彈迫緊調整片	RUBBER CHAMMER ADJUST	S09	擊鐵卡榫扭簧	HAMMER CATCH SPRING
P15	彈匣底座配件	MAGAZINE BASE JOINT	F05	導桿回位墊圈	RECOIL SPRING RING	S10	撞針扭簧	FIRING PIN SPRING
P39	氣流控制件	FLOATING VALVE	R01	子彈迫緊	RUBBER CHAMMER	S13	導桿回位壓簧	RECOIL SPRING
P60	彈匣底內件	MAGAZINE BOTTOM CAP	R02	氣嘴迫緊	GAS ROUTE	S14	射嘴回位壓簧	LOADING NOZZLE RECOIL SPRING
			G002	O型環 1X2id	O-RING 1X8	S15	保險壓簧	SAFERT SPRING
Z02	本體	FRAME	G010	O型環 1X8	O-RING 1X2	S16	導桿回位緩衝壓簧	RECOIL BUFFER SPRING
Z04	槍管導管	OUTER BARREL	G016	O型環 P U S-4(黃)	O-RING S4	S17	保險連動件扭簧	SAFERT CONNECT SPRING
Z05	擊鐵箱(左)	CHASSIS CASE (L)	G039	O型環 2X15	O-RING 2X15	KG15-S20	氣流控制件壓簧	FLOATING VALVE SPRING
Z06	擊鐵箱(右)	CHASSIS CASE (R)	KG15-L12	彈匣上部軸	MAGAZINE RIB PIN	EA016	Φ2.0X6 束鉸熱螺絲	SCREW 2.0X6
Z07	扳機	TRIGGER	B02	擊鐵箱左軸	CHASSIS PIN(L)	EA041	ΦM3.0X6.0XP0.5 鍍螺絲	SCREW M3.0X6.0XP0.5
Z08	導管卡榫	SLIDE CATCH	B03	扳機軸	TRIGGER PIN	EA045	ΦM3.0X8XP0.5 鍍螺絲	SCREW M3.0X8XP0.5
Z09	扳機箱	TRIGGER BASE	B04	扳機連桿軸	TRIGGER BAR PIN	EA061	Φ直 2.3X5 束鉸熱螺絲	SCREW 2.3X5
Z10	彈匣卡榫(左)	MAGAZINE CATCH (L)	B05	槍柄螺絲	GRIP SCREW	EA063	Φ直 2.3X6 黑螺絲	SCREW 2.3X6
Z11	彈匣卡榫(右)	MAGAZINE CATCH (R)	B06	保險軸	SAFETY PIN	EA064	Φ直 2.3X6 束鉸熱螺絲	SCREW 2.3X6
Z12	撞針卡榫	FIRING PIN CATCH	B08	擊鐵箱軸	CHASSIS CASE PIN	EA108	止付螺絲 4.0X4XP0.7黑	SCREW 4.0X4XP0.7
Z13	擊鐵壓簧導桿座	MAIN SPRING HOUSING	B09	氣閥本體	VALVE FRAME	EB002	彈簧墊圈	SPRING WASHER
Z14	擊鐵	HAMMER	B10	心棒後部	VALVE REAR	EC006	彈簧梢2X8黑	SPRING PIN 2X8
Z15	擊鐵卡榫	HAMMER CATCH	B11	槍管	BARREL	EC029	彈簧梢PSPSR2-8	SPRING PIN PSPSR2-8
Z16	撞針	FIRING PIN	B15	後準星上下調整螺絲	REAR SIGHT ADJUST SCREW (UP & DOWN)	U1	六角扳手	WRENCH
Z17	槍管左蓋	BARREL CAP (L)	B16	後準星左右調整螺絲	REAR SIGHT ADJUST SCREW (L & R)	U2	氣閥組件	VALVE UNIT
Z18	槍管右蓋	BARREL CAP (R)	B17	後準星座軸	REAR SIGHT BASE PIN	U3	氣瓶頂針組件	INNER VALVE UNIT
Z19	槍管導桿	OUTER BARREL	B18	前準星軸	FRONT SIGHT PIN	U4	彈匣組件	MAGAZINE UNIT
Z20	氣缸	BERRECH	B30	氣瓶頂針	PUNCTURE VAVLE	U5	扳機箱組件	TRIGGER BASE UNIT
Z21	保險(左)	SAFETY (L)	B33	心棒	VALVE	U6	擊鐵箱組件	HAMMER UNIT
Z22	保險(右)	SAFRTY (R)	B215	氣瓶頂針迫緊	PUNCTURE VAVLE PACKING	X1	內槍管組件	INNER BARREL UINT
Z23	保險釋放件	SAFETY RELEASE	B001	φ1.0鋼珠	BEARING φ1.0	X2	氣缸半組件	BREECH UNIT
Z31	後準星	SEAR SIGHT	B004	SUS 3.0φ鋼珠	BEARING SUS 3.0φ			

AAKCCB74 系列零件分解圖 AAKCCB74 SERIES EXPLODED VIEW

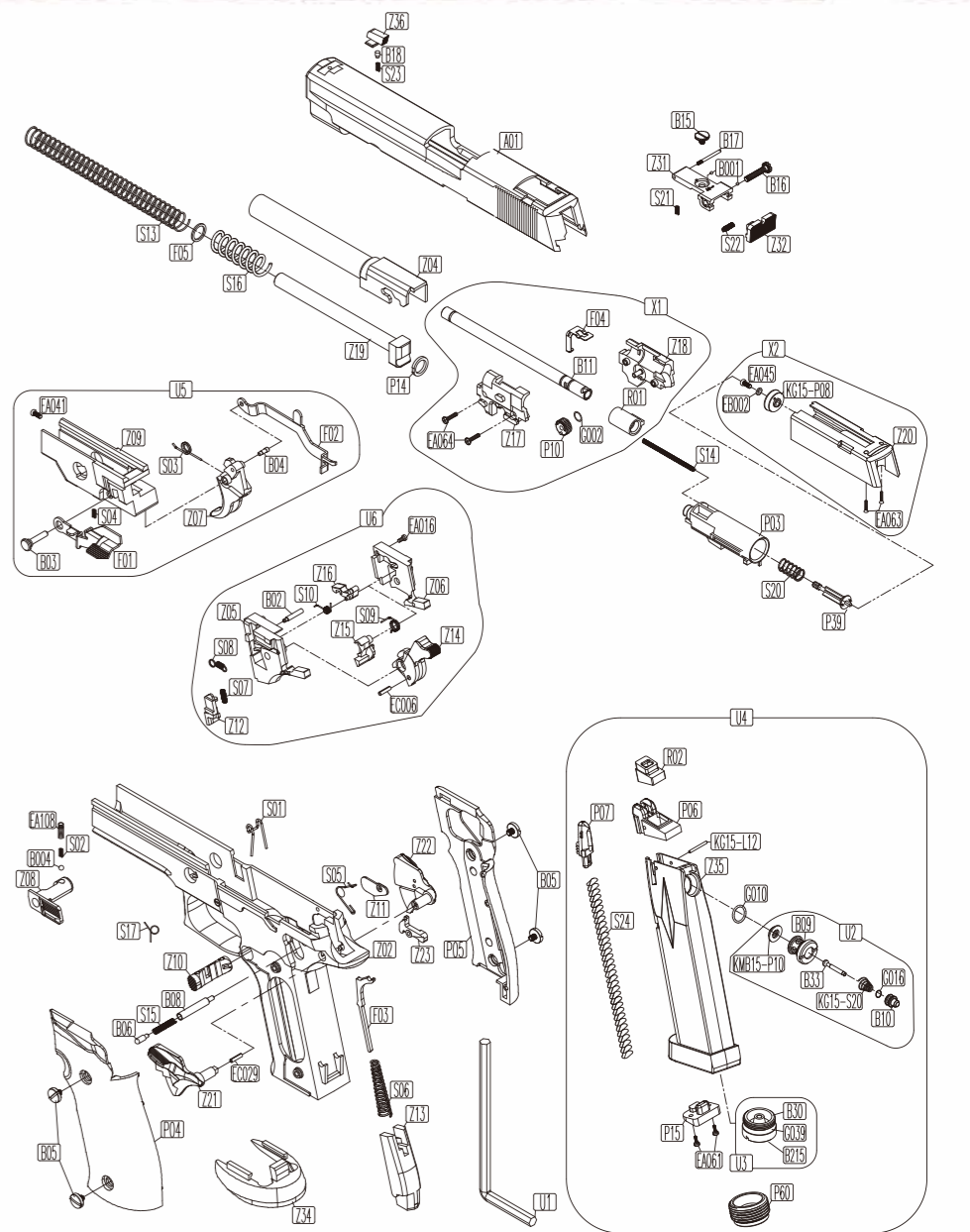

※零件有時為了改良而不經預告變更。
Spare parts may be modified for quality improvement
And such modification may be without advance notice.